



Global Packaging

and

Shipping Manual

Packaging and Shipping Standards for Production Parts

REVISION HISTORY

Date of Release	Comments
October 7, 2009	Initial Release – Nexteer Automotive Corporation
March 29, 2010	Links to drawings of the Nexteer Automotive standard manually handled expendable container on page 28 removed, title of SCRR changed to SCR on page 35 and throughout document (no change to definition)
March 21, 2016	Added Mexican Weight Trigger and removed unused carton columns.
December 9, 2016	Revised pallet height limits (pg 8). Added new SPI revision sample (pg 32).

FOREWORD

Prepared by the Nexteer Automotive Packaging Activity in cooperation with Logistics, Packaging Engineering, Industrial Engineering, Production Control and Global Supply Management, this manual provides standards for packaging and shipping products into Nexteer Automotive facilities.

1	INTRODUCTION-----	5
2	PACKAGING DEVELOPMENT & APPROVAL-----	7
3	GENERAL REQUIREMENTS-----	8
	PRICING-----	8
	DESIGN -----	8
	PACKAGING AGREEMENT SUBMISSION-----	9
	CHOOSING THE RIGHT CONTAINER-----	9
	DECISION PROCESS CONTAINER RIGHTSIZING-----	10
	ERGONOMIC REQUIREMENTS-----	11
	TESTING AND VALIDATION-----	13
	HAZARDOUS MATERIALS-----	13
4	EXPENDABLE PACKAGING SYSTEMS-----	14
	PALLET SIZE AND CONSTRUCTION-----	14
	CONTAINER SIZE AND CONSTRUCTION-----	16
	CONTAINER CLOSURE-----	19
	CONTAINER SECUREMENT-----	19
	SYSTEM PERFORMANCE CHARACTERISTICS-----	20
	UNACCEPTABLE DESIGN CHARACTERISTICS-----	20
	EXPORT / IMPORT REQUIREMENTS-----	20
5	RETURNABLE PACKAGING SYSTEMS-----	21
	MAINTENANCE REPAIR AND CLEANING-----	21
	RETURNABLE PACKAGING OWNERSHIP-----	22
6	INTERNAL DUNNAGE-----	23
7	SHIPPING LABELS-----	23
8	MIXED LOADS-----	24
9	PACKAGING EXAMPLES-----	25
10	RECYCLING INFORMATION-----	26
	RESIN IDENTIFICATION CODES-----	26
	WASTEFUL EXCESSIVE OR NON-RECYCLABLE MATERIAL-----	27
11	FORMS AND SUPPLEMENT REQUIREMENTS-----	28
	Attachment A1 – Standard Container Menu: North American Standards-----	29
	Attachment A2 – Standard Container Menu: International Standards-----	30
	Attachment A3 – Standard Container Menu: North American Standard Returnables-----	31
	Attachment B – Supplier Packaging Information Form (SPI)-----	32
	GLOSSARY OF TERMS-----	33

1 INTRODUCTION

As an integral part of the Nexteer Automotive Customer Specific Requirements detailing how to do business with Nexteer Automotive, the Nexteer Automotive Global Packaging & Shipping Manual specifies the packaging /shipping standards for material being shipped to Nexteer Automotive. The requirements in this manual must be applied to all current and future parts shipped to Nexteer Automotive; they take precedence over any previous guidelines or requirements.

The intent of these standards is to ensure safe movement, part quality, freight cube optimization, lean implementation and control of total costs. The responsibility for ensuring quality of material shipped remains with the supplier throughout the material movement process. Compliance to all local regulations is required.

The following are basic requirements that a supplier must adhere to in both the development of a packaging plan and the application of the shipping requirements. Upgraded standards may be required for your specific applications. Additionally, these requirements may be modified by supplemental requirements of the receiving Nexteer Automotive facility. The use of these standards or approvals of the Nexteer Automotive Supplier Packaging Information (SPI) form does not relieve the supplier of responsibility for part quality. These requirements should be applied to all production parts prior to quote submission. Nexteer Automotive's Divisional Supplier Packaging Leader must approve all exceptions.

It is expected that each supplier will develop their plan to comply; all packaging changes must be managed through the Nexteer Automotive Change Management Process. Further, it is expected each supplier will assure all affected employees are knowledgeable and capable of compliance. It is the supplier's responsibility to ensure part quality from their plant to the point of use within Nexteer Automotive. If part quality is compromised, the supplier may be held liable for repacking, inspection and incremental freight costs.

Goals:

1. All parts received with superior part quality.
2. Parts presented with operator ergonomics and work cell efficiency considered.
3. Achieve maximum pack density while minimizing costs.
4. Provide for responsible final disposition of obsolete packaging materials by maximizing the use of recyclable materials to minimize disposal.
5. All parts received are to follow the size requirements as specified in the Nexteer Automotive Standard Container Menus (See pages 31-33).
6. Facilitate the maximum utilization of the cubic shipping footprint.

2 PACKAGING DEVELOPMENT & APPROVAL

Nexteer Automotive Responsibilities

- Define the preferred packaging system (expendable/returnable).
- Approve the packaging plan utilizing the SPI process.
- Assist the supplier with the packaging plan as required.
- Determine system size, quantity, and allocation of returnable containers. Monitor and assure compliance to Nexteer Automotive requirements.

Supplier Responsibilities

- Review this document to ensure all requirements are clearly understood and met.
- Discuss with your Nexteer Automotive contact any specific requirements of the receiving Nexteer Automotive manufacturing facility.
- Ensure that pack validation can be completed within program start up dates.
- Returnable packaging designed, owned, and provided by the supplier must be approved by the Nexteer Automotive's Divisional Supplier Packaging Leader before shipments commence. The supplier's name and the container identification must be clearly visible on each returnable container.
- Submit a completed SPI form to Nexteer Automotive Global Supply Management with all part quote submissions.
- Resubmit SPI form with all proposed packaging changes (follow Supplier Change Request (SCR) process).
- When requested, provide for approval sample production intent packaging with parts.
- Design a back up expendable system when a returnable system is used (of same size or smaller than returnable footprint, and equal to returnable standard pack quantity) which may be required for premium shipments, production run ahead programs, returnable container outages, etc. Plan and maintain sufficient supply of suitable expendable packaging. Alternate pricing for expendable packaging costs must be prearranged with Nexteer Automotive Global Supply Management.
- Suppliers are responsible for designing their own expendable packaging. This includes the expendable packaging for the primary container, expendable dunnage used within expendable and returnable containers, and expendable back-up packaging for returnable container systems.
- Suppliers must monitor governmental & industry regulations to ensure their packaging conforms to all applicable requirements.
- All production intent parts must be shipped in production intent packaging; including PTR's.

3 GENERAL REQUIREMENTS

PRICING

Packaging costs must be included in all part quotations and clearly defined in the piece price.

- Supplier Packaging Information form must be submitted to Nexteer Automotive Global Supply Management.
- All packaging pricing must be negotiated with Nexteer Automotive Global Supply Management.
- No price increases will be granted to correct defective and/or non-conforming packaging.
- Pricing of returnable systems must be cost justified considering system size requirements, freight, housekeeping and lean material handling/processing costs.
- Pricing should include any returnable buffers required to support any internal manufacturing process. Nexteer Automotive will not pay for additional containers to support supplier buffers.
- Note at time of quote, any plans to reuse or reconstruct expendable system items (pallets, cartons, etc.).

DESIGN

Packaging Systems:

- Expendable packaging is considered mainstream.
- Maximum load heights (containers plus pallet) must not exceed 48 in (1220 mm).
- The stacked load must have the strength to stack three high (when full) in storage or to a height of 10.5 feet (3.2 m), whichever is greater.
- Nexteer Automotive's modular packaging system will facilitate the maximum utilization of the cubic shipping footprint, in-plant storage and point-of-use presentation. This system is based on two sizes; a 48" x 45" x 48" cube and 1200mm x 800mm x 1100mm cube. It has individual container sizes and is designed for safe manual handling, limiting individual loaded container weights based on container sizes and weight triggers.
- Reference container menus are provided on pages 29-31 of this manual.
- Package design and standard pack quantity (pieces per container) shall not vary except when approved by Nexteer Automotive.
- Suppliers are responsible for designing their own expendable packaging. This includes the expendable packaging for the primary container, expendable dunnage used within expendable and returnable containers, and expendable back-up packaging for returnable container systems.
- Suppliers may receive assistance from the packaging suppliers and/or from Nexteer Automotive. This does not relieve them of their responsibility to provide a quality part.
- When a returnable container system is required by Nexteer Automotive, suppliers are responsible to provide a design that meets all Nexteer Automotive requirements, while ensuring part integrity during shipment.
- If there are specialized design requirements, Nexteer Automotive may choose to assume responsibility for the packaging design.

PACKAGING AGREEMENT SUBMISSION

Nexteer Automotive Supplier Packaging Information (SPI) form represents an agreement between Nexteer Automotive and the Supplier regarding the packaging plan for products received by Nexteer Automotive manufacturing facilities.

- For all quotations, suppliers must submit a SPI form for each part number.
- Changes to part number, quantities, packaging materials or dimensions require a re-submittal of the SPI form (follow SCR process).
- All exceptions or deviations to Nexteer Automotive's standard packaging menus must be approved by Nexteer Automotive's Divisional Advanced PC&L Representative. Approvals of the Nexteer Automotive Supplier Part Information form in no way relieve the supplier of responsibility for part quality.
- The SPI form is located at the supplier portal under Supplier Standards/ Packaging

CHOOSING THE RIGHT CONTAINER

If a specific container requirement has not been indicated in the request for quote, use the Decision Process for Container Rightsizing (page 10) to select the container. This rightsizing model along with the Standard Container Menus (See Attachments A1 through A3) ensures the best rightsized container is chosen to optimize the entire material flow process from supplier through user. All Containers shipped to Nexteer Automotive manufacturing facilities must be chosen from the Nexteer Automotive Standard Container Menus. These menus represent the required container sizes, both for expendable and returnable cartons/containers, approved by Nexteer Automotive. However, when product dimensions dictate, an alternate container size will be permitted. Exceptions to the Standard Container Menu must be pre-approved.

Suppliers must document selected container plans by completing the SPI form.

Decision Process for Container Rightsizing

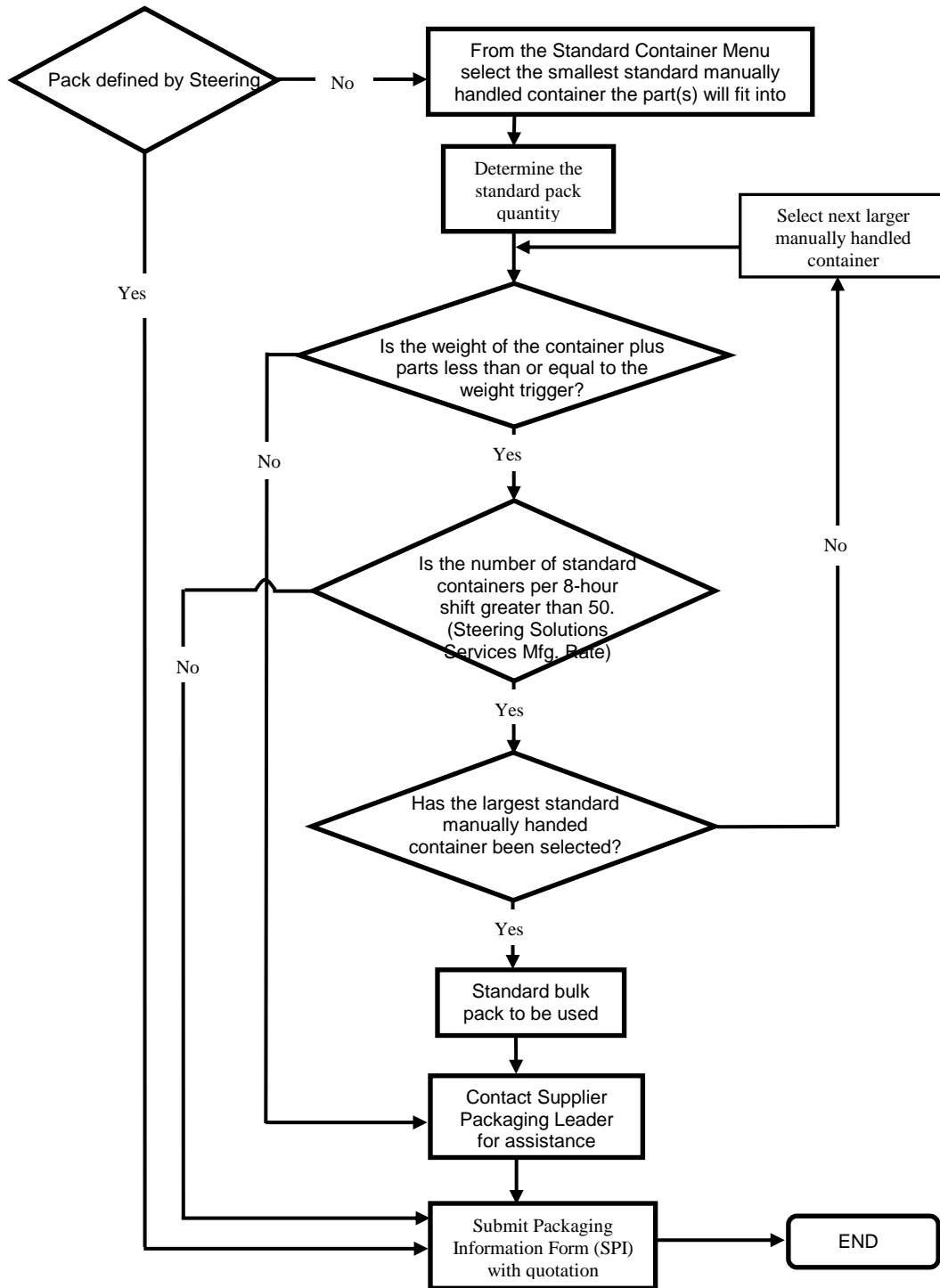

ERGONOMIC REQUIREMENTS

Weight: The maximum acceptable weight of a loaded container depends upon container specifics in addition to workplace and human factors. As such, ergonomic analyses must be performed on a case-by-case basis to be considered *valid* for risk assessment purposes.

The weight limit of containers may be specified in the quote package. If no weight limit is specified, then use the following chart to determine the loaded container weight guideline for the container size selected.

Note for clarification: the Weight Trigger is the weight under which the loaded container poses a low risk of injury thus no further analysis is needed. If the container exceeds its Weight Trigger, further analysis is needed using the NIOSH lifting equation (this takes into account frequency, vertical heights of the origin and destination, asymmetry of lift/lower, etc.) to assess the level of risk.

If the weight of the loaded container is greater than the Weight Trigger in the table below, make sure that the smallest feasible container size has been selected, or reduce the quantity of parts in the container to reduce the weight below the Weight Trigger.

If this is not possible, additional ergonomic analysis will need to be done to determine if the loaded container weight is acceptable. This takes into account the specific conditions in which the manually handled container will be used in the Nexteer Automotive facility.

When a Weight Trigger has been exceeded, approval to use the container is needed from Nexteer Automotive's Divisional Supplier Packaging Leader.

Size		Ergonomic Weight Limits	
IN	MM	US Weight Trigger	Mexican Weight Trigger
9 x 9 x 4	229 x 229 x 102	33 lbs	22 lbs
9 x 9 x 6	229 x 229 x 102	33 lbs	22 lbs
12 x 7.5 x 4	305 x 191 x 102	35 lbs	22 lbs
12 x 15 x 4	305 x 381 x 102	26 lbs	22 lbs
12 x 15 x 7.5	305 x 381 x 191	26 lbs	22 lbs
24 x 15 x 4	610 x 381 x 102	26 lbs	22 lbs
24 x 15 x 7.5	610 x 381 x 191	26 lbs	22 lbs
24 x 15 x 11	610 x 381 x 280	26 lbs	22 lbs
24 x 15 x 14.5	610 x 381 x 369	26 lbs	22 lbs
24 x 22.5 x 7.5	610 x 572 x 191	21 lbs	22 lbs
24 x 22.5 x 11	610 x 572 x 280	21 lbs	22 lbs
24 x 22.5 x 14.5	610 x 572 x 369	21 lbs	22 lbs

The Weight Triggers for other US containers (plus parts) in the Nexteer Automotive Standard Container Menu may be calculated using the following formula:

$$\text{Weight Trigger} = \frac{410 \text{ in-lbs}}{(0.5 * \text{container width (inches)} + 8 \text{ inches})}$$

Any manually handled container not listed in the Nexteer Automotive Standard Container Menu is considered non-standard. Handling of non-standard containers may be ergonomically acceptable if the weight of the loaded container does not exceed its calculated Weight Trigger.

Other Factors to Consider for all containers:

- If handholds are required, apply the following:
 - Select the appropriate type of handhold for the container such as: hinged access holes for expendable containers; D-shaped and molded handles for returnable containers.
 - Properly dimension handholds to accommodate gloved hands.
 - Position handholds above the center of gravity.
- Containers should be rigid and not allow excessive flexing, bowing, buckling or distortion.
- There should be no sharp or protruding edges/ridges.
- The following dunnage designs should be considered:
 - Part-orientation within container should match the part orientation used by operator.
 - Allow access space for fingers/hand during part placement and removal.
 - Minimize the force required for part placement/removal.

TESTING AND VALIDATION

Packaging testing is the most efficient means of ensuring the integrity and safety of contents and performance of the pack. It is the suppliers' responsibility to ensure part integrity during transportation and subsequent handling and storage through point of use. The supplier should test the pack design under simulated and/or real-life conditions. The approval by Nexteer Automotive of the packaging system does not relieve the suppliers of their responsibility for part integrity. The supplier should provide Nexteer Automotive with validation results and testing documentation as they become available.

Testing and Validation References

- ASTM (American Society for Testing and Materials)
- ISTA (International Safe Transit Association)

HAZARDOUS MATERIALS

- The supplier is responsible for assuring shipment of hazardous materials are in compliance with all government regulations or any other relevant international, federal, state, provincial or local requirement.
- The supplier is responsible for informing Nexteer Automotive of any packaging that contains materials that may render the packaging "hazardous" as defined by the laws of the country or countries where the packaging is to be used. This information should be in the form of a notification to the supplier's purchasing contact that includes the Nexteer Automotive Part Number and the hazardous constituent of concern that is incorporated in the packaging. Approval for the transfer of ownership to the using plant of hazardous packaging will require the approval of the plant environmental engineering personnel based on the availability of suitable, economical disposal.
- The shipping and receiving location's Hazardous Material Committee must approve any additives on the parts or within the package for temporary corrosion inhibition prior to usage.
- Any corrosion inhibiting measure must be compatible with mating assemblies if the additive is to remain on the part.
- The supplier is required to provide "Material Safety Data Sheets" to the transporter of the material as well as the shipping and receiving location's Hazardous Material Committee.

4 EXPENDABLE PACKAGING SYSTEMS

PALLET SIZE AND CONSTRUCTION

Size: Nexteer Automotive standard footprints are governed by the size and cube of transporting conveyance. For Nexteer Automotive Standard Pallet Menu see Attachment A4. Non standard pallets require approval.

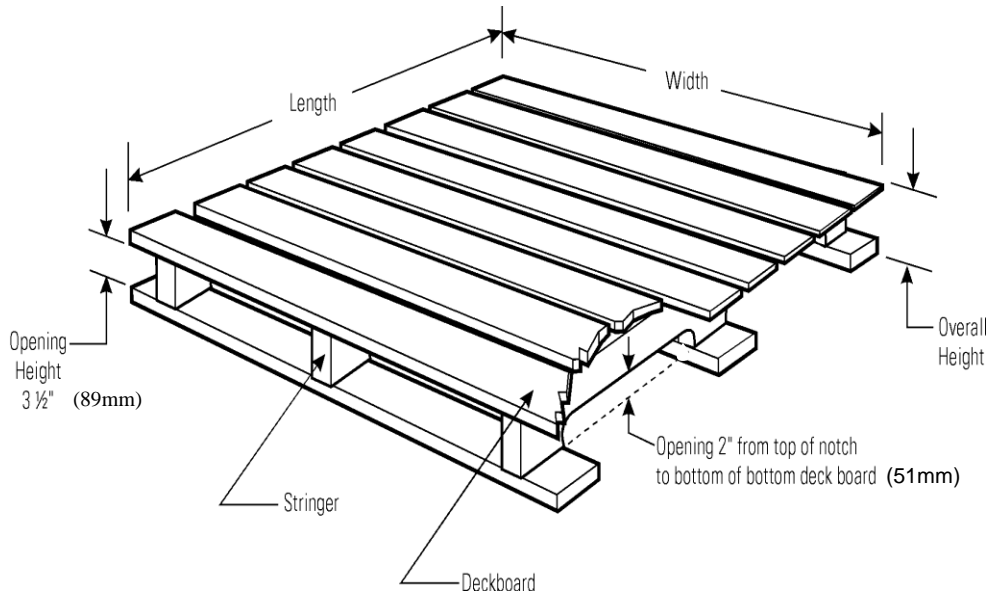

North American Standards: A 48" (1219 mm) x 45" (1143 mm) x 5" (127 mm) pallet has 48" (1219 mm) stringers, 45" (1143 mm) deck boards and the top of the deck is 5" (127 mm) above the floor. For the four-way entry pallet, the primary (easy entry) opening is across the 45" (1143 mm) width.

Non-reversible four-way entry stringer wood pallets, with 3.5" (89 mm) minimum primary opening height are required. Two-way entry may be used on 32" (812 mm) x 30" (762 mm) pallets.

International Standards: An 800 mm (31.5 in) x 1200 mm (47.2 in) x 145 mm (5.7 in) pallet has 800 mm (31.5 in) stringers, 1200 mm (47.2 in) deck boards and the top of the deck is 145 mm (5.7 in) above the floor. For the four-way entry pallet, the primary (easy entry) opening is across the 1200 mm (47.2 in) width.

Non-reversible four-way entry stringer construction wood pallets, with 89 mm (3.5 in) minimum primary opening height are required. Two-way entry may be used on 800 mm (31.5 in) x 600 mm (23.6 in) pallets.

Construction: The pallet must have the minimum strength to withstand the static and dynamic forces foreseen for the distribution environment. Pallet design criteria must be incorporated to prevent pallet deformations, damages and structural failures which detrimentally affect the functionality of the unit load. Refer to ASTM D1185 designation – Standard Test Methods for Pallets and Related Structures Employed in Materials Handling and Shipping – for testing details and pallet acceptance criteria. Additional requirements that will apply are as follows:

- Wood Pallets
 - Nailed construction is required. Minimum 2 ¼” (57mm) long, four-flute helical hardened nails are recommended.
 - Deck boards should be spaced close enough to provide adequate support to the product and prevent the product from falling through.
 - The pallet must have the strength to stack three high (when full) in storage or to a height of 10.5 feet (3.2m), whichever is greater.
 - Structural members of the pallet should be compatible with the carton by supporting the edge and corners.
 - All pallets must comply to ISPM#15 regarding non-manufactured wood products (NMWP) regardless of country origin or destination. These requirements provide guidance on the treatment and marking of coniferous and non-coniferous wooden packaging products. For information regarding the international guidelines: International Phytosanitary Portal [IPP] at <https://www.ippc.int/IPP/En/default.jsp>
 - Identification of manufacturer and / or pallet name printed on a visible pallet stringer is required.
 - Pallets may be new, reconditioned or reconstructed. However, if reconstructed must be retreated and show markings that indicate conformance to ISPM #15.
 - Nail heads and points are to be flush but may not exceed 1/8”(3mm) exposure from surface.
 - No missing or broken deck boards top or bottom.
 - No tapered breaks greater than 1” (25mm) or longer than 10” (254mm) in length.
 - All stringers must be solid, not broken or have cracks visible from 3 sides or longer than 1” (25mm); weathering cracks allowable if meet above.
 - No double stringers, patched boards or metal plates.
 - No partial footing where stringer is ¼” (6mm) missing or deck nail shanks are exposed.
 - No exposed splinters greater than 3” (76mm).
 - Pallets must be clean and odor free. Aging discoloration acceptable.
- For pallets used in export applications, refer to the Export / Import Requirements on page 18 of this manual.

CONTAINER SIZE AND CONSTRUCTION

- The expendable container system has been designed to be modular. All material must be shipped in box sizes shown in the Nexteer Automotive Standard Container Menu. This allows for effective layering and utilization of the standard pallet dimensions. Any deviation to using the Nexteer Automotive Standard Container Menu requires prior authorization by Nexteer Automotive's Divisional Supplier Packaging Leader and SPI approval prior to shipment of the material. The following are expected when creating a load of material:
 - Containers must be palletized to ensure part protection and to permit handling with industrial trucks when sufficient quantities are to be shipped.
 - Brick stacking is prohibited due to loss in compression strength.

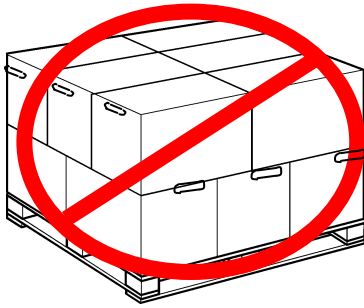

Brick stacking is prohibited.

- Flute direction must be vertical (corrugated pattern in wall of carton must have visible spaces in the vertical direction) to optimize compression strength of the carton.

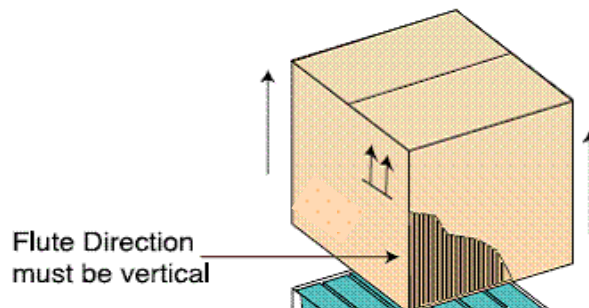

- Containers must be aligned and fully utilize the length and width of the pallet due to compression strength loss.

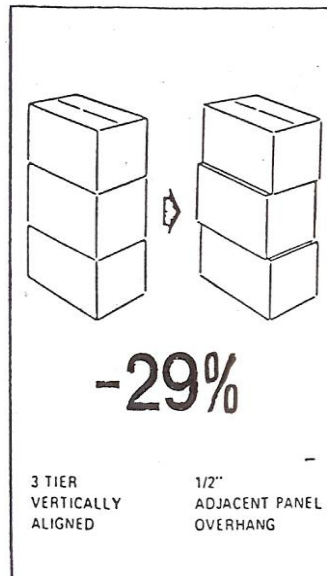

Non-alignment by 1" (25mm) results in a 29% compression loss

- To ensure load integrity, containers must not overhang the pallet.

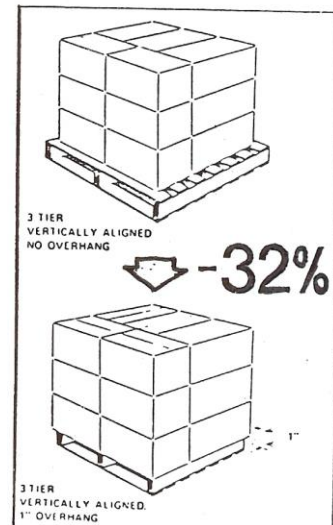

Overhang on pallet by 1" (25mm) – results in a 32% compression loss

CONTAINER SIZE AND CONSTRUCTION continued

- Regular Slotted Containers (RSC) and Half Slotted Containers (HSC) may be used (see Attachment A1, A2, and A3).
- When HSCs are used, one common cover over each full layer of cartons on a pallet is the preferred method; although in some cases individual lids may be required. The use of uncovered (uncapped) HSCs is not acceptable.
- Corrugated material in shipping containers must have adequate strength to allow the parts to arrive at the using location in the same quality condition in which they were manufactured.
- A minimum 44 ECT/7.7kN/m (edge crush test) is required.
- Parts plus dunnage should completely fill the container to prevent collapsing because of excessive voids.
- Packaging materials coated or impregnated with wax or plastics must have prior authorization.
- All containers must be constructed with an outside tab style manufacturer's joint. A stitched manufacturer's joint is required if a glued or other type joint proves inadequate.
- All containers must have a box maker's certificate visible on the assembled container displaying edge crush (ECT) or bursting strength.
- The use of scored drop sides on palletized cartons may be required. Although normally on the longer side of the container, the location and size of the drop side is determined by part orientation and operator ergonomics. Consult your Nexteer Automotive Divisional Supplier Packaging Leader if further clarification is required.
- Wire bound wood pallet boxes or wood crates are not acceptable.
- Prior approval is required to use wood composite crates.
- Expendable container systems based on paper products, paperboard, fiberboard or similar materials must be designed to withstand an environmental atmosphere of 40 +/- 2°C (104 +/- 4°F) with a 85 +/- 5% relative humidity. Suggested pre-condition environment considers a temperature of 23.0 +/- 1.0°C (73 +/- 2°F) with a 50 +/- 2% relative humidity. Refer to ASTM D685 designation – Standard Practice for Conditioning Paper and Paper Products for Testing – and ASTM D4332 designation – Standard Practice for Conditioning Containers, Packages or Packing Components for Testing or ISO2233 Packaging – Complete, filled transport packages and unit loads – Conditioning for Testing – for additional details.
- Any other expendable container system must be designed to withstand temperature variations from (-) 29°C to (+) 60°C [(-) 20°F to (+) 140°F] with relative humidity variations up to 85 +/- 5%. Refer to ASTM D4332 – Standard Practice for Conditioning Containers, Packages or Packaging Components for Testing or and ISO2233 Packaging – Complete, filled transport packages and unit loads – Conditioning for Testing – for details on environmental considerations.

CONTAINER CLOSURE

Closure refers to the method in which containers must be sealed, after being filled, for shipping and handling. Containers must be adequately sealed to assure they do not open during shipping or handling. Taping or gluing is accepted for closure. Avoid staples for container closure. Packaging materials containing asphalt, such as asphalt sealing tapes are prohibited.

If any specific tool or methodology is required to open the container, it is mandatory to gain prior Nexteer Automotive approval.

CONTAINER SECUREMENT

All expendable containers shipped on pallets must be adequately secured to the pallets. Nails, screws, metal staples, metal strapping, metal clips or banding buckles, glue or PVC film to secure loads to pallets are prohibited.

The following are acceptable methods for securing cartons to a pallet:

- Plastic (Non-Metallic) Strapping –
 - A minimum of two vertical bands lengthwise and two vertical bands widthwise must be used.
 - Horizontal banding of corrugated boxes is prohibited.
 - Polyester strapping is required. Nexteer Automotive's Divisional Supplier Packaging Leader must approve use of any other strapping material.
 - Strapping color must be standardized.
 - Polyester strapping must be translucent green.
 - If polypropylene strapping is approved, it must be translucent clear.
 - Non-metallic strapping must be joined with a friction seal.
 - Metal clips or buckles are prohibited.
 - Metal strapping is prohibited.

- Stretch film –
 - Stretch film must be linear low-density polyethylene (LLDPE) and clear in color. Stretch film must have enough clarity to enable bar code scanning of labels.
 - PVC film is not permitted.
 - A minimum of three layers of stretch film, or the equivalent in performance, are required around and encompassing the pallet. Stretch film must securely capture the pallet when wrapping the bottom layer.

SYSTEM PERFORMANCE CHARACTERISTICS

- Maximum load heights (containers plus pallet) must not exceed 52 in (1320 mm).
- All packs must be level layered. No pyramid stacking of cartons is allowed.
- The stacked load must have the strength to stack three high (when full) in storage or to a height of 10.5 feet (3.2 m), whichever is greater.
- The use of DO NOT STACK label, which is prohibited, will not exempt the supplier from over, short or damaged product claims and will be grounds for a Problem Report.
- Maximum weight of any load (containers plus pallet) is 2000 pounds (907.18 kg).
- Container designs must provide for dynamic (in transit) loading of three times the static (in storage) load and must have sufficient strength to stack to a height of 104 in. (2640mm) in a trailer. Suitable non-stapled corner supports and top stacking frames may be necessary to meet this requirement.
- All container designs must be stackable.
- Air freight shipments, LTL (less than truckload), and other special shipments are subject to abnormal handling and require more substantial packaging.

UNACCEPTABLE DESIGN CHARACTERISTICS

- Pyramid stacking of containers disallowing load stacking.
- Misalignment of containers causing crushing.
- Use of “Do Not Stack” labels, which are prohibited.
- Overweight containers.
- Insufficient container strength to protect components.
- Multiple footprints disallowing standard loading patterns.

EXPORT / IMPORT REQUIREMENTS

Below are the general requirements to be followed when shipping parts from one country to another country:

- Supplier will monitor governmental & automotive industry regulations for changes related to packaging & shipping information.
- When shipping by airfreight, special reinforced packaging may be necessary.
- Packaging materials shall protect part quality for a minimum of 30 days for Intra-continent shipments and minimum of 90 days for Inter-continent shipments.

5 RETURNABLE PACKAGING SYSTEMS

A returnable has a design and function permitting it to be used more than once in a defined supplier-customer system. All returnable containers will include a cardholder and/or a label placard. The tare weight must be stamped into the individual components of the container system.

MAINTENANCE, REPAIR AND CLEANING

Nexteer Automotive Responsibilities

- The Nexteer Automotive facility, when shipping empty containers, will assure the containers are free of debris and expendable packaging materials.
- Provide maintenance, repair and funding for Nexteer Automotive owned systems.

Supplier Responsibilities

- Clean returnable containers, including residue, and expendable dunnage, when required. Routine checks should be made and regular cleaning should occur as needed to ensure part quality and cleanliness during the life of the container.
- Load production parts into clean undamaged containers only and load the container systems into the transportation equipment in a manner that maintains part quality.
- Contact receiving plant's material personnel for repair if a damaged container or pallet is detected. Remove damaged unit immediately from the system.
- Remove all one-time shipment labels on returnable packaging.
- Suppliers shall store containers in a manner, which allows ease of inventories, maintains cleanliness and protects containers from excessive environmental exposure.

RETURNABLE PACKAGING OWNERSHIP

Nexteer Automotive Responsibilities

- Control the ownership/handling of returnable container systems.
- Coordinate any economic feasibility study to assure acceptable return on investment.
- Provide recommended returnable system.
- Approve system size and returnable system proposals.
- Provide disposition of obsolete/damaged containers.
- Provide instructions to container manufacturers on proper marking of the returnable containers and required documents in support of Customs special trade or tariff reduction programs. Returnable containers must include the markings “Container made in (country)” and a unique identifier such as the container number.

Supplier Responsibilities

- Nexteer Automotive returnable containers are to be used only for shipment of Nexteer Automotive products and are to be maintained in good order. Under no circumstances will damaged packaging be used for shipments to Nexteer Automotive facilities.
- Assure accurate container identification and quantities (including pallets, returnable dunnage and containers) are included in all ASNs (Advance Shipping Notice).
- Maintain continuous shipping and receipt records of all Nexteer Automotive owned returnable packaging including:
 - Outbound shipments by container and location.
 - Supplier in-plant reserve.
 - Balance not returned from each Nexteer Automotive receiving location.
- Inspect all containers upon return and document any damaged containers.
- Contact the Nexteer Automotive receiving plant’s Production Control Department when shortages begin to occur.

6 INTERNAL DUNNAGE

Internal dunnage is considered to be a packaging component that requires a pallet or container to be shippable (e.g. vacuum formed trays, corrugated partitions, layer pads, etc.). Dunnage can be used in both returnable and/or expendable systems. Dunnage shall be used when part-to-part contact must be eliminated to prevent damage in shipping and handling or in cases where special part orientation as provided in your quote package is requested. Suppliers are responsible for the design, performance, and procurement of all expendable dunnage. Container loading, unloading, and waste recycling / disposal must be considered when designing interior dunnage. The use of dunnage constructed of combined and / or non-recyclable materials is discouraged.

7 SHIPPING LABELS

Below are the general requirements to be followed when labeling:

- Supplier is responsible to ensure correct labeling is provided for all packaging. Review the label standards at the Supplier Portal Select “Supplier Standards” and then select Supplier Label Specifications. North American and European standards are provided.
- Labels must be legible.
- All labels must be electric scanner compliant.
- If placards are available on containers, use this area to apply shipping labels.
- Any deviations must be reviewed and approved by the receiving Nexteer Automotive’s Plant Production Control.
- Where container size does not adequately provide for the use of standard shipping labels, contact the appropriate approver listed within the Label Standards document.

8 MIXED LOADS

A mixed load occurs when more than one part number is shipped on a pallet. (Note: Loads should never be mixed in a bulk container system.) A mixed load should be considered mainstream when frequency of delivery requires less than full pallet loads. This also allows better cube utilization of the transportation system. When shipping a mixed load the following requirements must be met:

- A mixed load label must be affixed to the load on two adjacent corners where the shipping label is normally attached. In addition, a mixed load manifest or packing slip must be attached to the load that indicates the part numbers shipped and how many containers are associated with each part number.
- The packing slip will designate the entire contents of the load.
- Similar part numbers will be grouped together on the pallet for ease of identification and accountability.
- The mixing of containers on a single skid destined for different plants or delivery docks is not allowed.
- The containers must be positioned on the pallet so the label faces the outside perimeter of the pallet for ease of identification. When possible, all labels should be visible to ease identification and accountability requirements.
- Care should be taken to balance the load by distributing the weight as evenly as possible, remembering that similar products must be grouped.
- The load may require special attention to secure the containers if void and or irregular configuration occurs. Stretch wrap is the preferred method.
- Level layers are the requirement. This allows better cube utilization of the transportation system. Mixed loads may be necessary in order to achieve this condition. A “mixed load” may have the following conditions:
 - Single or multiple part number(s) on a pallet mixed w/ empty containers.
 - Multiple part numbers on a pallet.
- Guidelines for mixing loads:
 - If the Nexteer Automotive receiving facility is ordering the material in layer quantities – mixed loads are not allowed unless receiving facility has authorized.
 - If the Nexteer Automotive receiving facility is ordering the material by box (carton) quantity – then mixing loads is permissible.
 - A MASTER label for each part number and a MASTER label must be present on the pallet, indicating pallet contents.
 - When mixing part numbers on a pallet, the heaviest parts must be placed on the bottom layer.

9 PACKAGING EXAMPLES

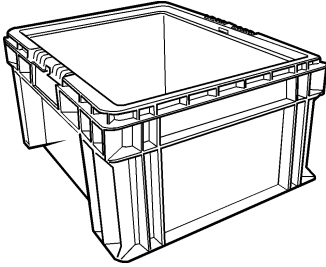

Manually Handled Returnable

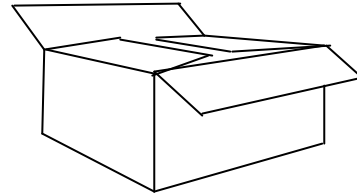

Manually Handled Expendable

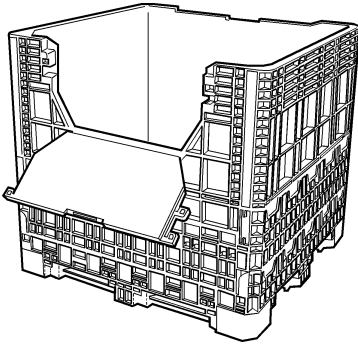

Bulk Returnable

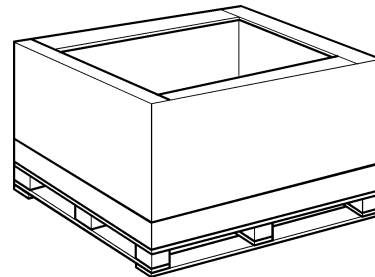

Bulk Expendable

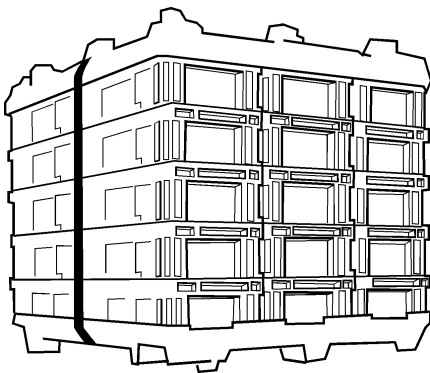

Palletized Load Returnable

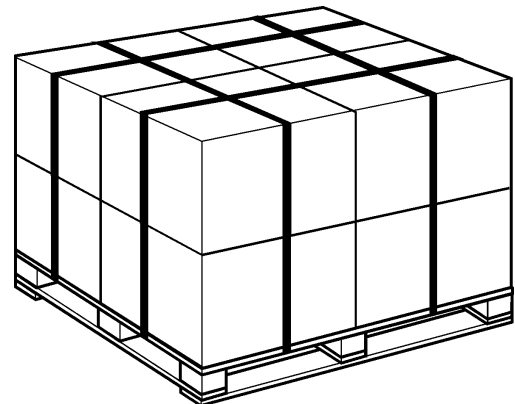

Palletized Load Expendable







10 RECYCLING INFORMATION



Resin Identification Codes

To facilitate the recycling of a product, its identity must be known. There are numerous types of plastics used for automotive packaging which require a simple method of identification. Nexteer Automotive will require the Resin Identification Codes; the same as on retail packaging. The resin identification code chart is shown below. All vacuum-formed and injection-molded plastic packaging material must be identified by this code.

NOTE: Plastic components that are assembled to the vehicle are to be identified with the proper resin identification code to facilitate recycling. Packaging material must be marked with the appropriate resin identification code.

Recycling Number	Abbreviation	Polymer Name
 PETE <small>Ima</small>	PETE or PET	Polyethylen Terephthalate
 HDPE <small>File</small>	HDPE	High Density Polyethylene
 V <small>File</small>	PVC or V	Polyvinyl Chloride
 LDPE <small>Ima</small>	LDPE	Low-Density Polyethylene
 PP	PP	Polypropylene
 PS	PS	Polystyrene
 OTHER	OTHER	Other plastics including acrylic, polycarbonate, polylactic acid, nylon and fiberglass.



WASTEFUL, EXCESSIVE, OR NON-RECYCLABLE MATERIAL

Packaging is required to serve many needs; part protection, transportation effectiveness, lean manufacturing, and ergonomic and environmental concerns to name a few. Proposed and impending state and federal legislation is prohibiting wasteful and/or excessive packaging. The challenge is to meet these requirements with the amount and degree of packaging necessary and no more. Over-packaging and wasteful “just-in-case” packaging is undesirable for both the supplier and the user. Each Nexteer Automotive supplier is expected to identify and correct such packaging on an ongoing basis.

**With reduction or elimination as the first priority,
the hierarchy of waste elimination is:
REDUCE →→→ REUSE →→→ RECYCLE**

To list every example of wasteful, excessive or non-recyclable packaging would be too extensive. We have identified a few examples that have been significant problems at the plants.

- Cartons partially filled.
- Oversized foam, plastic or corrugated dunnage.
- Micro cellular foam wrap and bubble wrap.
- Plastic protective covers, caps, plugs, paint masks or spacers required in the manufacturing process, but not required as a protective shipping device.
- Corrugated carton test strength that far exceeds requirements.

Non-recyclable packaging is that which has no available or economical system in place to process an item. Wax-coated corrugated is a prime example of this type of packaging. Waxed- or plastic-coated paper is prohibited, unless otherwise directed by Nexteer Automotive.

Plastic plugs, caps, and protectors are extremely difficult to recycle due to oil and paint contamination, colors, uncertainty of resin type, and transportation costs. Every effort should be made to eliminate the plastic. If it cannot be eliminated, other changes can be made to assist the plants’ recycling efforts.

- Mold the appropriate plastic recycling code into the part. When elimination is not possible, these codes will allow for effective recycling.
- Clear LDPE plastics are preferred and can be effectively recycled.
- Ship plastics uncontaminated with paints and lubricants.
- Replace the plastic with a paper substitute.

Any plastic cap, plug, spacer, etc. not required for packaging or shipping protection must be removed prior to shipment.

11 FORMS AND SUPPLEMENT REQUIREMENTS

Attachment A1: Standard Container Menu: North American Standards

Attachment A2: Standard Container Menu: International Standards

Attachment A3: Standard Container Menu: North American Standard Returnables

Attachment A4: Standard Pallet Menu: North American & International Standards

Attachment A5: Standard Packaging Materials: Miscellaneous Materials – tape, stretch film, layer pads, banding, partitions, corner boards, spools, reels, etc.

Attachment B: Nexteer Automotive Supplier Packaging Information Form (SPI)

Attachment C: Cube Utilization

Attachment D: Supplier Packaging Selection Checklist

Attachment E: Supplier Ship Compliance Checklist

Attachment F: Packaging Receiving Checklist

References (available at most libraries and bookstores):

ASTM (American Society for Testing and Materials)

ISTA (International Safe Transit Association)

ISPM (International Standards for Phytosanitary Measures)

SPI (Society of Plastics Industry)

Links to Additional References

Nexteer Automotive Ergonomics website <http://apollo.Steering Solutions Servicesauto.net/ergonomics/>

Attachment A1 – Standard Container Menu: North American Standards

Expendable Manually Handled Containers

Outside Dimensions		Pallet Size	Containers per Layer	Max. # Layers on Secondary Container	Tare Weight (lbs)	Container Type	Inside Dimensions			
Inches	Millimeters						Length	Width	Depth	
Regular Slotted Cartons (RSC)										
9 x 9 x 4	229 x 229 x 102	48 x 45	25	11						
9 x 9 x 6	229 x 229 x 153	48 x 45	25	7						
12 x 7.5 x 3.75	305 x 191 x 102	48 x 45	24	11	0.4	RSC	11-5/8	7-1/8	3-1/8	
12 x 15 x 3.75	305 x 381 x 102	48 x 45	12	11	0.9	RSC	11-5/8	14-5/8	3-1/8	
12 x 15 x 7.5	305 x 381 x 191	48 x 45	12	6	1.1	RSC	11-5/8	14-5/8	6-7/8	
24 x 15 x 3.75	610 x 381 x 102	48 x 45	6	11	1.3	RSC	23-5/8	14-5/8	3-1/8	
24 x 15 x 7.5	610 x 381 x 191	48 x 45	6	6	1.5	RSC	23-5/8	14-5/8	6-7/8	
24 x 15 x 11.25	610 x 381 x 280	48 x 45	6	4	1.8	RSC	23-5/8	14-5/8	10-5/8	
24 x 15 x 14.5	610 x 381 x 369	48 x 45	6	3	2.0	RSC	23-5/8	14-5/8	13-7/8	
24 x 22.5 x 7.5	610 x 572 x 191	48 x 45	4	6	2.4	RSC	23-5/8	22-1/8	6-7/8	
24 x 22.5 x 11.25	610 x 572 x 280	48 x 45	4	4	2.7	RSC	23-5/8	22-1/8	10-5/8	
24 x 22.5 x 14.5	610 x 572 x 369	48 x 45	4	3	3.1	RSC	23-5/8	22-1/8	13-7/8	
Half Slotted Cartons (HSC)										
11-11/16 x 7-7/16 x 3-11/16	281 x 189 x 93.7	48 x 45	24	11	0.3	HSC	11-1/4	7	3-1/16	
11-11/16 x 14-7/8 x 3-11/16	281 x 200 x 93.7	48 x 45	12	11	0.5	HSC	11-1/4	14-7/16	3-1/16	
11-11/16 x 14-7/8 x 7-3/8	281 x 200 x 187.3	48 x 45	12	6	0.7	HSC	11-1/4	14-7/16	6-3/4	
23-7/16 x 14-7/8 x 3-11/16	595.3 x 200 x 93.7	48 x 45	6	11	0.8	HSC	23	14-7/16	3-1/16	
23-7/16 x 14-7/8 x 7-3/8	595.3 x 200 x 187.3	48 x 45	6	6	1.0	HSC	23	14-7/16	6-3/4	
23-7/16 x 14-7/8 x 11-1/16	595.3 x 200 x 281	48 x 45	6	4	1.3	HSC	23	14-7/16	10-7/16	
23-7/16 x 14-7/8 x 14-3/4	595.3 x 200 x 374.7	48 x 45	6	3	1.5	HSC	23	14-7/16	14-1/8	
23-7/16 x 22-5/16 x 7-3/8	595.3 x 566.7 x 187.3	48 x 45	4	6	1.5	HSC	23	21-7/8	6-3/4	
23-7/16 x 22-5/16 x 11-1/16	595.3 x 566.7 x 281	48 x 45	4	4	1.9	HSC	23	21-7/8	10-7/16	
23-7/16 x 22-5/16 x 14-3/4	595.3 x 566.7 x 374.7	48 x 45	4	3	2.2	HSC	23	21-7/8	14-1/8	
HSC Layer Covers										
12-13/16 x 7-13/16 x 2	325.4 x 198.4 x 50.8				0.23	Cover	11 11/16	7 7/16	2.0	
16 x 12-1/16 x 2	406.4 x 306.4 x 50.8				0.37	Cover	14 7/8	11 11/16	2.0	
24-9/16 x 15-1/4 x 2	623.9 x 387.4 x 50.8				0.59	Cover	23 7/16	14 7/8	2.0	
24-9/16 x 22-11/16 x 2	623.9 x 576.3 x 50.8				0.82	Cover	23 7/16	22 5/16	2.0	
48 x 45 x 3	1219.2 x 1143 x 76.2				2.8	Cover	46-7/8	44-5/8	3.0	

Attachment A2 – Standard Container Menu: International Standards

Manually Handled Containers

Expendable Carton (MM)	Returnable Container (MM)	Pallet Size (MM)	Containers per Layer
International Standards			
	200 x 150 x 140	600 x 800	
300 x 200 x 150	297 x 198 x 148 VDA	1200 x 800	16
300 x 200 x 150	300 x 200 x 114 Galia	1200 x 800	16
300 x 200 x 200	300 x 200 x 214 Galia	1200 x 800	16
400 x 300 x 150	396 x 297 x 148 VDA	1200 x 800	8
400 x 300 x 150	400 x 300 x 114 Galia	1200 x 800	8
400 x 300 x 200	396 x 297 x 280 VDA	1200 x 800	8
400 x 300 x 200	400 x 300 x 214 Galia	1200 x 800	8
400 x 300 x 300	400 x 300 x 280 Galia	1200 x 800	8
600 x 400 x 200	594 x 396 x 280 VDA	1200 x 800	4
600 x 400 x 200	600 x 400 x 214 Galia	1200 x 800	4
600 x 400 x 300	600 x 400 x 314 Galia	1200 x 800	4

Preferred Pallet Sizes (MM)
1200 x 800
1200 x 1000

Acceptable Pallet Sizes (MM) (requires prior approval)
600 x 800
600 x 1000

Bulk Containers (MM)
800 x 600 x 465
1200 x 1000 x 860
1200 x 1000 x 975

This listing provides rightsized standards for returnable and expendable containers. The dimensions shown should be considered outside dimensions.

Attachment A3 – Standard Container Menu: North American Standard Returnables

Manually Handled Returnable Containers

IN	MM	Pallet Size	Containers per Layer	Max. # Layers on Secondary Container	Tare Weight (lbs)	Material	
North American Standards							
12 x 7.5 x 4	305 x 191 x 102	48 x 45	24	11	1.1	HDPE	(XL)
12 x 15 x 4	305 x 381 x 102	48 x 45	12	11	2.0	HDPE	(XL)
12 x 15 x 7.5	305 x 381 x 191	48 x 45	12	6	2.7	HDPE	(X)
24 x 15 x 4	610 x 381 x 102	48 x 45	6	11	3.0	HDPE	(X)
24 x 15 x 7.5	610 x 381 x 191	48 x 45	6	6	4.6	HDPE	(X)
24 x 15 x 11	610 x 381 x 280	48 x 45	6	4	5.0	HDPE	(X)
24 x 15 x 14.5	610 x 381 x 369	48 x 45	6	3	8.3	HDPE	(X)
24 x 22.5 x 7.5	610 x 572 x 191	48 x 45	4	6	6.9	HDPE	(X)
24 x 22.5 x 11	610 x 572 x 280	48 x 45	4	4	7.3	HDPE	(X)
24 x 22.5 x 14.5	610 x 572 x 369	48 x 45	4	3	11.3	HDPE	(X)

Preferred Pallet Sizes	
IN	MM
48 x 45	1219 x 1143

Acceptable Pallet Sizes (Prior approval required)	
IN	MM
30 x 32	762 x 813
32 x 36	813 x 914

Returnable Bulk Containers	
IN	MM
32 x 30 x 25	813 x 762 x 635
32 x 30 x 34	813 x 762 x 864
48 x 45 x 25	1219 x 1143 x 635
48 x 45 x 34	1219 x 1143 x 864

Note: These are rightsized returnable containers and all dimensions are outside dimensions.

Legend: (X) Cross Stack Container
(XL) Cross Stack Container with a Hinged Lid

Attachment B – Nexteer Automotive Supplier Packaging Information Form (SPI) – Example Only



Link below is to Nexteer Global Packaging and Shipping Manual:

http://www.nexteer.com/wp-content/uploads/2012/FILES/PACK_SHIP/packaging_%20manual.pdf

SUPPLIER PACKAGING INFORMATION

* Supplier is responsible for a dunnage design that insures 100% quality upon delivery to Nexteer's point of use.

NEXTEER PROVIDED INFORMATION:

Section 1 (Completed by Nexteer)	NEXTEER BUYER		BUYER PHONE NUMBER	E-MAIL / FAX	DATE SUBMITTED
	Part Number (s)		Part Description		Annual Volume
	Pack Option <input type="checkbox"/> Expendable <input type="checkbox"/> Returnable with Expendable Backup		Nexteer Using Plant (s)		Program / Model Year
	SPECIAL PACKAGING REQUIREMENTS & CONSTRAINTS (Also, see "Additional Comments" below) <input type="checkbox"/> Part Orientation Critical (see "Additional Comments Below") <input type="checkbox"/> Individual Containers Must Have Lids <input type="checkbox"/> Restriction of Part Movement <input type="checkbox"/> Small Lot Pkg (gross weight limit 12 kgs, 10 kgs for Mexico) <input type="checkbox"/> Bags or Disposable Liners Req'd <input type="checkbox"/> ESD Protection Req'd <input type="checkbox"/> Surface Finish is Critical (Part Separation) Req'd <input type="checkbox"/> Part Cleanliness is an Issue <input type="checkbox"/> Pallet Box Side Access				
double-click here Nexteer contact Advanced PC&L logon Name Date Phone Email					

ADDITIONAL COMMENTS

SUPPLIER PROVIDED INFORMATION:

SUPPLIER COMPANY NAME				DATE SUBMITTED
SHIPPING ADDRESS (STREET; CITY, STATE ZIP)		MANUFACTURING ADDRESS (STREET; CITY, STATE ZIP)		
SUPPLIER SCHEDULING CONTACT NAME		EMAIL	PHONE	
SUPPLIER PACKAGING CONTACT NAME		EMAIL	PHONE	

RETURNABLE PACK INFORMATION

Primary Container Type (Box, Tote, etc)	DESCRIPTION / Item #	LWH (mm)	TARE WT (kg)	MATERIAL (n/a)
DUNNAGE TYPE (VCI, partitions, etc)	DESCRIPTION / Item #	LWH (mm)	TARE WT (kg)	MATERIAL (n/a)
DUNNAGE TYPE (VCI, partitions, etc)	DESCRIPTION / Item #	LWH (mm)	TARE WT (kg)	MATERIAL (n/a)
Secondary Container (pallet, pallet-box, etc)	DESCRIPTION / Item #	LWH (mm)	TARE WT (kg)	MATERIAL (n/a)
PALLET STACKABILITY (2-high, 3 high, etc) * 1-high or "Do Not Stack" unacceptable		PROOFING METHOD (VCI PAPER, VCI BAG, DESICCANT BAGS, OIL, NONE)		PRIMARY BOX HAVE HANDLES (Y or N)
STANDARD PACK QUANTITY (per primary container)		NO. OF PRIMARY CONTAINERS/LAYER	NO. OF LAYERS ON/IN SECONDARY CONTAINER	
PART WEIGHT (kg)	PRIMARY CONT GROSS WEIGHT (kg)	SECONDARY CONT GROSS WEIGHT (kg)	METHOD TO SECURE LOAD (stretch wrap, banding, etc)	MATERIAL

EXPENDABLE PACK INFORMATION

Primary Container Type (box, tote, etc)	DESCRIPTION / Item #	LWH (mm)	TARE WT (kg)	MATERIAL
DUNNAGE TYPE (VCI, partitions, etc)	DESCRIPTION / Item #	LWH (mm)	TARE WT (kg)	MATERIAL
DUNNAGE TYPE (VCI, partitions, etc)	DESCRIPTION / Item #	LWH (mm)	TARE WT (kg)	MATERIAL
Secondary Container (pallet, pallet-box, etc)	DESCRIPTION / Item #	LWH (mm)	TARE WT (kg)	MATERIAL
PALLET STACKABILITY (2-high, 3 high, etc) * 1-high or "Do Not Stack" not acceptable		PROOFING METHOD (VCI PAPER, VCI BAG, DESICCANT BAGS, OIL, NONE)		PRIMARY BOX HAVE HANDLES (Y or N)
STANDARD PACK QUANTITY (per primary container)		NO. OF PRIMARY CONTAINERS/LAYER	NO. OF LAYERS ON/IN SECONDARY CONTAINER	
PART WEIGHT (kg)	PRIMARY CONT GROSS WEIGHT (kg)	SECONDARY CONT GROSS WEIGHT (kg)	METHOD TO SECURE LOAD (stretch wrap, banding, etc)	MATERIAL

INSERT PHOTOS HERE

Part Only	Part + Interior Dunnage + Primary Box	Primary + Secondary Unit Load

SUPPLIER FEEDBACK

NEXTEER APPROVALS

Concept Agreement	double-click here Plant PC&L	Name	Date	double-click here Plant I.E.	Name	Date
-------------------	---------------------------------	------	------	---------------------------------	------	------

NEXTEER FEEDBACK

GLOSSARY OF TERMS

Adhesive - A material capable of attaching one surface to another. As used in connection with fibre boxes; a material to glue plies of solid fibreboard, to glue facings to corrugating medium in combined corrugated board, to glue the overlapping sides of a box forming the manufacturer's joint or to glue the flaps in closing a slotted box.

Box (Carton) - A rigid container having closed faces and completely enclosing its contents.

Box Maker - Corrugated or solid fibre box manufacturing establishment which has equipment to score, slot, print and join corrugated or solid fibre sheets into boxes, which equipment is regularly utilized in the production of fibre boxes in commercial quantities.

Brick Stacking - Act of alternating the stacking of containers on pallets, length by width and width by length.

Bursting Strength - The strength of material expressed in pounds per square inch.

Closure - The method used to seal a container once the parts have been packaged within it.

Containerization - Packaging parts in the smallest lot possible resulting in presentation of a quality part to eliminate waste of motion for the manufacturing operator. *Note:* The best container for the operator is no container.

Containment - Contain the product from point of manufacture until delivery at its point of use.

Cross Stack - A feature molded into the bottom of returnable manually handled container that allows a larger container to stack on top a number of smaller containers.

Deck - The horizontal load-carrying or load-bearing surface of a pallet.

Deck Opening - Any void in the deck caused by the spacing of surface elements or a cutout in a solid deck pallet.

Deckboard - The surface element used in the construction of a pallet deck.

Distribution Environment - The entire material flow process from supplier through user.

Duns Number - A number designation code assigned to shippers by Dun & Bradstreet.

Dunnage - Devices or materials used to hold, secure, or protect goods during shipment.

Expendable - A pack that makes only one trip.

Edge Crush Test (ECT) – Corrugated board test to determine the force that will crush a standard size of board standing on an edge. ECT indicated the probable compression strength of the container made from the board.

Footprint - The outermost dimensions (length and width) of a pallet, container or container system.

Four-way Pallet - A pallet constructed to allow insertion and withdrawal of handling equipment from all sides of the pallet.

Height -The overall dimension of the container in the vertical direction.

Half Slotted Container - Same as Regular Slotted Container without one set of flaps (a box which requires a separate lid).

Joint - That part of the box where the ends of the scored and slotted blank are jointed together by taping, stitching, or gluing. When accomplished in the box manufacturer's plant, it is known as a manufacturer's joint; when effected at the time the box flaps are sealed in a box user's plant (usually on automatic equipment), it is called a user's joint.

Lean Logistics Network – A centralized consolidated logistics system that manages and optimizes the Nexteer Automotive North American material movement. The purpose is to increase efficiency in material delivery, increase delivery frequency, leverage the overall Nexteer Automotive volume to reduce the North American cost structure while providing planned, predictable material delivery. Deliver the right part, in the right quantity at the right time.

Mixed Load – more than one part number shipped on/or in a single secondary container.

Overhang - That portion of the unit load that exceeds the width or length dimension of a pallet. (Not allowable).

Pack Validation –The process used to test the basic functions of containment and protection.

Pad - A corrugated or solid fibreboard sheet or other authorized material used for extra protection or for separating tiers or layers of articles when packed for shipment.

Pallet - A horizontal platform device used as a base for assembling, storing, handling, and transporting materials and products in a unit load.

Performance - Perform in various ways for enabling packing, handling, storage, transportation, unpacking, disposal, etc.

Placard – An easy release label or card holder area affixed to a container for the purpose of placing a label or kanban card.

PPAP - Production Part Approval Process.

Primary Container - The shippable container closest to the parts.

Protection – To protect the product from various hazards encountered in the distribution environment.

Returnable – A pack that makes multiple trips.

Rightsizing - Containerization that optimizes the entire material flow process from supplier to user.

Regular Slotted Container - Corrugated box where all flaps have the same length, and the two outer flaps (normally the lengthwise flaps) are one-half the container's width, so that they meet at the center of the box when folded.

SCR (Supplier Suggestion/Change Request) – Used to submit supplier cost savings suggestions and ideas to Nexteer Automotive.

Score - Impression or crease in corrugated or solid fibreboard to locate and facilitate folding. (See also Slit-Score).

Seam - The junction created by any free edge of a container flap or wall where it abuts or rests on another portion of the container and to which it may be fastened by tape, stitches or adhesives in the process of closing the container.

Secondary Container - Larger container on which multiple primary containers are shipped.

Secondary Container Length – Length of the secondary container. For wood pallets, it is the dimension of the stringers or stringer boards.

Secondary Container Width – Width of the secondary container. For wood pallets, it is the dimension of the top deck boards of a pallet.

Standard Pack - The Primary Container.

Standard Pack Quantity - Number of pieces in a shippable primary container.

Stitching or Stapling - Application of metal fasteners to form the joint of fibre boxes or to close boxes. Stitches are machine-formed using wire drawn from a spool. Staples are performed.

Stringer - A continuous longitudinal board member of a pallet that supports the horizontal load-carrying or load-bearing surface.

Tape - A strip of cloth or paper, sometimes having a filler or reinforcement, coated on one side with an adhesive. It is used to form the joint on a fibre box or to close or reinforce such a box. Closure and reinforcement can also be affected with pressure-sensitive tape.

Tare Weight - Weight of the container(s), excluding the weight of the parts.

Test; Bursting Strength (Mullen) - Measurement of the resistance of a material to bursting expressed in pounds per square inch. The test is made on a motor-driven Mullen tester.

Top Deck - Load-carrying surface.

Unit Load Height – The overall height of the primary containers when stacked on the secondary container, measured from the bottom of the secondary container to the top of the highest primary container. For bulk containers, it is the height of the secondary container.

Weight Trigger – The weight under which the loaded container poses a low risk of injury thus no further analysis is needed. If the container exceeds its weight trigger, further analysis is required.

Nexteer Automotive

World Headquarters

3900 Holland Road
Saginaw Michigan 48601
U.S.A.
Tel: 989-757-3532
Fax: 989-757-3533